

Smartgen[®]

HGM6320T

AUTOMATIC GENERATOR CONTROLLER

USER MANUAL

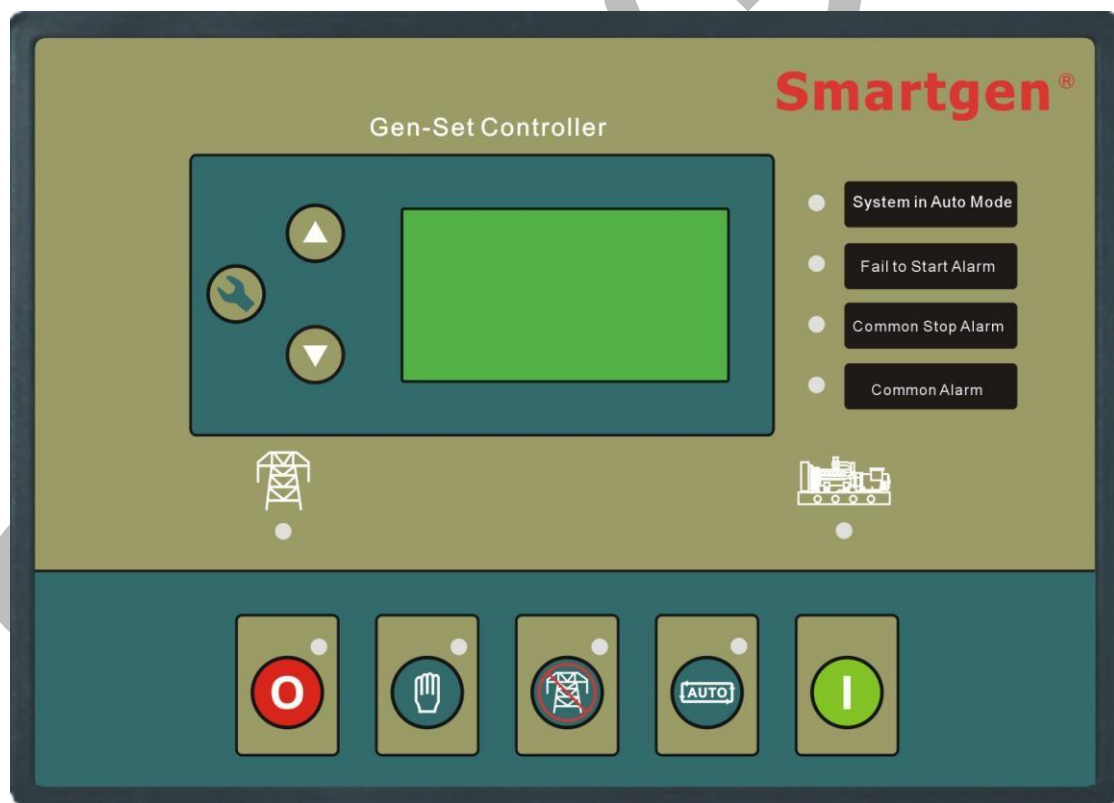

Smartgen Technology

CONTENT

1 SUMMARY	4
2 PERFORMANCE AND CHARACTERISTICS	4
3 SPECIFICATION.....	5
4 OPERATION	6
4.1 LCD DISPLAY	6
4.2 KEY FUNCTION.....	7
4.3 AUTOMATIC OPERATION.....	8
4.4 MANUAL OPERATION	9
5 ALARM PROTECTION	9
5.1 WARNINGS/PRE-ALARM.....	9
5.2 SHUTDOWN ALARM	11
5.3 ELECTRICAL TRIPS SHUTDOWN.....	12
5.4 AUTOMATICAL START CONDITIONS OF ENGINE	13
5.5 AUTOMATICAL STOP CONDITIONS OF ENGINE.....	13
5.6 AIR-CONDITIOING ATS ACTIONS	14
5.7 GSM MESSAGE ITEMS.....	14
5.8 GSMSHORT MESSAGE CONTROL.....	15
5.9 MAINS ELECTRIFY RULES.....	16
5.10EVENT LOG ITEMS	17
6 PANEL SETTING.....	18
6.1 PARAMETER EDITING	18
6.2 DATE AND TIME SETTING.....	23
7 DEFINITION OF INPUTS AND OUTPUTS.....	24
7.1 DEFINITION OF AUX. INPUT 1-6.....	24
7.2 DEFINITION OF AUX. OUTPUT 1-6.....	25
8. EVENT LOG VIEWING	29
9. COMMISSIONING.....	29
10. REAR PANEL	30
11 COMMUNICATION.....	33
12 TYPICAL WIRING DIAGRAMS	34
13 FAULT FINDING	35
14 OVER CURRENT CURVE	36
15 INSTALLATION.....	36

1 SUMMARY

HGM6320T automatic control module is specially designed for mobile communication base station, whose functions can be configured according to actual using of the station. It can not only control types of generators automatically, but can monitor temperature of engine room and battery voltage to control mains/load, and mains/double ATS switch. When alarm occurs, it can inform the servicing staff by sending short message.

HGM6320T controller adopts large liquid crystal display (LCD) and selectable Chinese and English interface with compact structure, advanced circuits, simple connections and high reliability.

2 PERFORMANCE AND CHARACTERISTICS

- ☐ Microprocessor control, big screen LCD with back-lit display, selectable Chinese and English interface, touch button operation;
- ☐ Precise measure and display function: almost can monitor all the related electricity parameter and water temperature, oil pressure, fuel level and so on;

Main monitoring items:

Mains 3 /single phase voltage

Gens 3 /single phase voltage

Load 3 /single phase current

Mains Frequency

Gens Frequency

Engine rotating speed

Engine rotating temperature

Oil pressure

Fuel level

Room temperature

Battery voltage

- ☐ With SMS function (can send message about mains normal/ abnormal, gensent start/stop, powering failure, ATS transfer timer to 5 cell phones, and phone number can be set);
- ☐ 4 conditions of crank disconnect: mains abnormal signal, remote start signal, room temperature and battery voltage. These 4 conditions can be combined randomly;
- ☐ External connect to temperature sensor for monitoring room temperature. Air condition in the test room will be started when temperature is high;
- ☐ Can control 2 ATS, and mains have priority;
- ☐ Can set a regular time in each month or each week to startup or shutdown.

- ☐ With function of prohibiting start at night;
- ☐ With international standard MODBUS communication protocol, and RS232/RS485 communication interface, can realized functions of remote control, remote measure, and remote communication of genset;
- ☐ Can control room fans automatically;
- ☐ With access detection ,which ensure the safety of engine room;
- ☐ With real calendar, clock and accumulation of running time;
- ☐ Accumulated output electric energy display;
- ☐ Can save 200 history records to make facilities faults diagnosis possible;
- ☐ Power supply range: (8~35) VDC, can adapt to12/24V start battery voltage environment.
- ☐ All the parameters adopt digital adjustment instead of traditional potentiometer analog adjustment, which improve reliability and stability;
- ☐ Modular design, anti-flaming ABS plastic shell, inserted-type connection terminals and built-in mounting. Structure compact with easy installation.









3 SPECIFICATION







ITEM	CONTENT
Working Voltage	DC8. 0V to 35. 0V, Continuous Power Supply
Power Consumption	<3W(Standby mode: ≤2W)
Alternator Input Range 3-Phase 4 Wire 3-Phase 3 Wire Single-Phase 2 Wire 2-Phase 3 Wire	15V AC - 360 VAC (ph-N) 30V AC - 600 VAC (ph- ph) 15V AC - 360 VAC (ph-N) 15V AC - 360 VAC (ph-N)
Alternator Input Frequency	50Hz /60Hz
Magnetic Volt Input Range	1.0V to 24.0V (RMS)
Magnetic Input Frequency	10,000 Hz (max)
Start Relay Output	16 Amp DC28V at DC supply output.
Fuel Relay Output	16 Amp DC28V at DC supply output.
Auxiliary Relay Output (1-3)	16Amp DC28V at DC supply output.
Auxiliary Relay Output (4-6)	16Amp 250VAC passive output.
Battery Voltage Range	(0-100)VDC
Ambient Temperature	(0-50)°C
Overall Dimensions	240mm x 172mm x 57mm
Panel Cutout	214mm x 160mm
C. T. Secondary	5A (rated)

Working Condition	Temperature: (-25~70)°C Humidity: (20~90)%
Storage Condition	Temperature: (-30~+80)°C
Protection Level	IP55: when with waterproof rubber ring added between controller and its panel. IP42: when without waterproof rubber ring between controller and its panel.
Insulation Intensity	Object: between input/output/power Quote standard: IEC688-1992 Test way: AC1.5 kV/1min 2mA leakage current
Weight	0.90kg









4 OPERATION

4.1 LCD DISPLAY

<p>SYSTEM IN STOP MODE MAINS NORMAL GENERATOR AT REST MAINS ON LOAD</p>	<p>The screen displays these states of gens working, mains, switch, and gens alarm information. It indicates that system in standby mode, main normal with load.</p>
<p>MAINS UL-L 381 381 381 V UL-N 220 220 220 V F = 50.0 Hz</p>	<p>Press  key or  key. The screen displays mains line voltage (L1-L2, L2-L3, L3-L1), phase voltage (L1, L2, L3), frequency.</p>
<p>GENERATOR UL-L 381 381 381 V UL-N 220 220 220 V F = 50.0 Hz 1500 RPM</p>	<p>Press  key or  key. The screen displays gens line voltage (L1-L2, L2-L3, L3-L1), phase voltage (L1, L2, L3), frequency and rotating speed.</p>
<p>FUEL LEVEL 80% ENGINE TEMP 80°C 176 °F OIL PRESSURE1 503 KPa 73PSI 5.03Bar</p>	<p>Press  key or  key. The screen displays gens fuel level, water/cylinder temperature, oil pressure. XXXX: not used; HHHH、LLLL: digital quantity input; ++++: sensor open circuit;</p>
<p>PLANT BATTERY 27.4 V CHARGER ALT 27.4 V ENGINE SPEED 1500 RPM 08-06-16 (1) 08:16:01</p>	<p>Press  key or  key. The screen displays gens battery voltage, charger voltage, engine rotating speed, and real time. (number in bracket refers to week)</p>

<p>GENERATOR STARTS 13 num HOURS RUN 00009:05:30 ENERGY 00561.6 kWh</p>	<p>Press  key or  key. The screen displays gens accumulated start times, electric energy, and run time (hour: minute: second)</p>
<p>LOAD IL 200 203 205 A POWER 140kW 179kVA Cosφ = 0.78 112kVar</p>	<p>Press  key or  key. The screen displays gens load current, active power, apparent power, power factor and reactive power.</p>
<p>AMBIENT TEMP 25°C 77°F PILE VOLT 53.5V OIL PRESSURE 2 503kPa 73 PSI 5.03Bar</p>	<p>Press  key or  key. The screen displays engine room temperature, plant battery voltage, and oil pressure2.</p>

4.2 KEY FUNCTION

	Stop/ Reset	<p>Can stop generator immediately during unit running; Can reset alarming when alarming occurs; To test if panel indicators are OK or not, (pressing this key at least 3 seconds); When enter into menu, press to exit the editor without stopping generator.</p>
	Start	<p>To start genset under Manual mode or manual test mode (with load).</p>
	Manual mode	<p>Pressing this key will set the module into manual mode.</p>
	Test On Load	<p>Pressing this key will set the module into manual test mode (with load).</p>
	Auto mode	<p>Pressing this key will set the module into automatic mode.</p>
	Menu	<p>Pressing this key will enter menu interface; In parameter configuration, press this key to shift bit or confirmation.</p>
	Up/Increase	<p>Press to scroll the screen. In parameter configuration, press to increase value.</p>
	Down/Decrease	<p>Press to scroll the screen. In parameter configuration, press to decrease value.</p>

4.3 AUTOMATIC OPERATION

Press , and the indicator besides the key illuminates, which indicates unit is in auto start mode.

Starting Sequence







- 1) When Mains or remote start inactive, enter into “start delay”, and LCD displays the count-down.
Note: if started through other starting conditions, will not enter into “start delay” but enter next process.
- 2) When start delay is over, preheat relay is output (if configured), “pre-heat start delay XX s” is displayed in LCD.
- 3) When pre-heat relay is over, fuel relay is outputting 1s and then start relay outputs; if genset fails to start within “cranking time”, the fuel and start relays stop outputting and enter into “crank interval time” to wait for next start.
- 4) If genset fails to start within setting times, the first line of LED will turn black and fails to start alarm will be displayed in LCD screen.
- 5) If crank disconnect any time, it will enter into “safety run time”. During this period, alarms of low oil pressure, high temperature, under speed, charge failure and auxiliary input (if fitted) are inactive. Enter into “start idle delay” after safety run delay (if start idle delay is configured).
- 6) During “start idle delay”, alarms of under speed, under frequency, under voltage are inactive. As soon as this start idle delay is over, genset will enter into “warm up delay” (if high speed warm up delay is configured).
- 7) When “warm up delay” is over, if generator normal, then indicator illuminates. If generator voltage and frequency reach load requirement, genset close relay outputs (transfer ATS from mains to gens), genset is on load, and genset will enter into normal running status; if genset voltage or frequency is abnormal, the controller will alarm to shutdown (alarm is displayed in LCD).

Stopping Sequence

- 1) Genset enters into “stop delay” as soon as battery voltage is over the setting threshold.
- 2) After stop delay ends, enter “high speed coolant delay”, and generator close relay is disconnected, ATS is transferred from gens to mains, and mains take load.
- 3) Idle relay is power-on outputting when enters “idle stop delay”.
- 4) Enter into “ETS delay”, ETS relay is power-on outputting. Fuel relay output is disconnected.
- 5) Genset can automatically judge if it is steady when the controller enters “Genset at rest time”.

- 6) After genset stops steadily, enters into standby status; if genset cannot stop, controller will alarm (LCD screen displays “fail to stop” warning).

4.4 MANUAL OPERATION

- 1) Press  key, module is in **Manual Mode** and its indicator illuminates.  key, then controller enters “**Manual Test Mode**” and indicator illuminates. Under the both modes, press  key to start genset. It automatically detects crank disconnect and accelerates to high speed running. When high temperature, low oil pressure, over speed and voltage abnormal occur during genset running, controller can protect to stop immediately. Under “**Manual Mode** ”, gens will not take load unless manual switching. Under “**Manual Test Mode** ”, after genset runs well in high speed, no matter mains is normal or not, loading switch must be transferred into Gens.
- 2) Manual stop, press  key can stop the running genset (please refer to No.3~6 of **AUTO** stop operation for more details).

5 ALARM PROTECTION

5.1 WARNINGS/PRE-ALARM

Warnings are non-critical alarm conditions, warn not shutdown. The first line of LCD screen turns black and displays alarm type.

For example,

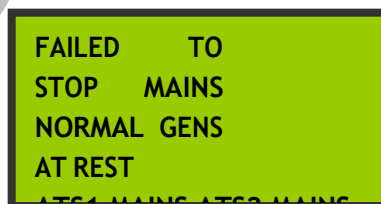
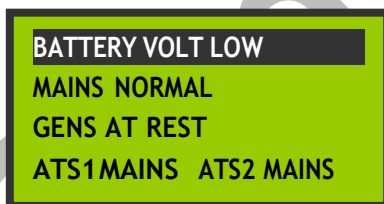

No.	Type	RANGE	DESCRIPTION
1	High Temp.	From start idle to stop idle	The module detects that the water temperature has exceeded the pre-alarm setting level. Controller sends alarming signal and LCD displays the warning.
2	Low Pressure Oil	From idle speed to stop idle	The module detects that the engine oil pressure has fallen below the low oil pressure pre-alarm setting. Controller sends alarming signal and LCD displays the warning.
3	Over Speed	Always active	The engine speed has risen above the over speed pre-alarm setting Controller sends

No.	Type	RANGE	DESCRIPTION
			alarming signal and LCD displays the warning.
4	Under Speed	From waiting load to cooling	The engine speed has fallen below the under speed pre alarm setting. Controller sends alarming signal and LCD displays the warning.
5	Loss Of Speed	From start idle delay to stop idle	If the speed sensing signal is lost during cranking, a warning will occur.
6	Over Frequency	Always active	The generator output frequency has risen above the pre-alarm setting. Controller sends alarming signal and LCD displays the warning.
7	Under Frequency0	From waiting load to cooling	The generator output frequency has fallen below the pre-set pre-alarm setting. Controller sends alarming signal and LCD displays the warning.
8	Over Voltage	From waiting load to cooling	The generator output voltage has risen above the pre-set pre-alarm setting. Controller sends alarming signal and LCD displays the warning.
9	Under Voltage	From waiting load to cooling	The generator output voltage has fallen below the pre-set pre-alarm setting. Controller sends alarming signal and LCD displays the warning.
10	Over Current	Always active	If the module detects a generator output current in excess of the pre-set trip a warning alarm initiates.
11	Fail To Stop	When ETS delay is over	The module has detected that the engine is running when it has been instructed to stop. Controller sends alarming signal and LCD displays the warning.
12	Fuel Level Low	Always active	The level detected by the fuel level is below the low fuel level setting. Controller sends alarming signal and LCD displays the warning.
13	Charge Failure	From waiting load to cooling	The auxiliary charge alternator voltage is low as measured from the W/L terminal. "Charging failure warning" will display in LCD screen.
14	Battery Under Volt	Always active	If the module detects battery voltage fallen below the pre-set, a warning alarm initiates.
15	Battery Over Volt	Always active	The module detects starter battery voltage has in excess of the pre-set, a warning alarm initiates.
16	Auxiliary Input 1-6	User defined	The module detects the alarming input auxiliary Input 1-6, LCD displays the warning.
17	Control Gate	Always active	The module detects that engine room is opened, a warning alarm initiates and displayed

No.	Type	RANGE	DESCRIPTION
			in the LCD.
18	GSM Disabled	SMS is enable	Controller cannot communicate with GSM module, a warning alarm initiates and displayed in the LCD.
19	Battery Under Volt	Always active	The module detects Pile voltage has fallen below the pre-set, a warning alarm initiates.
20	Ambient Temp High	Always active	The module detects the temperature of engine room over the pre-setting value, warning alarm initiates and displayed in the LCD. (When pass the max. limit, controller won't alarm but to start the generator.)
21	Maintenance Warn	Set maintenance as warning	When the pre-setting maintenance timer up, a warning alarm initiates and displayed in the LCD.

5.2 SHUTDOWN ALARM

When controller detects shutdown alarms, it will stop the generator immediately and disconnect close relay signals to disengage load. The alarms are displayed in LCD.

No.	TYPE	RANGE	DESCRIPTION
1	Emergency Stop	Always active	The emergency stop button has been depressed. This is a failsafe input and will immediately stop the genset. It will be displayed in LCD.
2	Engine High Temperature	From start idle to stop idle	The engine coolant temperature has exceeded the high engine temperature trip setting level after the Safety On timer has expired, and it will be displayed in LCD.
3	Low Oil Pressure	From idle speed to stop idle	The engine oil pressure has fallen below the low oil pressure trip setting level after the Safety On timer has expired, and it will be displayed in LCD.
4	Over speed	Always active	The engine speed has exceeded the pre-set trip, and it will be displayed in LCD.
5	Under speed	From waiting load to cooling	The engine speed has fallen below the pre-set trip after the Safety On timer has expired, and it will be displayed in LCD.

No.	TYPE	RANGE	DESCRIPTION
6	Loss Of Speed Signal	From start idle to stop idle	The speed signal from the magnetic pickup is not being received by the DSE controller.
7	Generator Over Frequency	Always active	The generator output frequency has risen above the preset level, and it will be displayed in LCD.
8	Generator Under Frequency	From waiting load to cooling	The generator output frequency has fallen below the preset level.
9	Generator Over Voltage	From waiting load to cooling	The generator output voltage has risen above the preset level.
10	Generator Under Voltage	From waiting load to cooling	The generator output voltage has fallen below the preset level.
11	Gens Current Over	Always active	When controller detects that genset current is over pre-set alarm or delay is not 0, it will send stop alarm signal and it will be displayed in LCD.
12	Fail To Start	When attempted crank times due	The engine has not fired after the preset number of start attempts.
13	Oil Pressure Sensor Open Circuit	Always active	The oil pressure sensor is detected as not being present (open circuit).
14	Auxiliary Inputs (1-6)	User defined	When the module detects the shutdown signal input, shutdown alarm initiates and displayed in the LCD.
15	Maintenance Shutdown	Set maintenance as shutdown	When the pre-setting maintenance timer up, a shutdown alarm initiates and displayed in the LCD.

5.3 ELECTRICAL TRIPSSHUTDOWN

Electrical trips are latching and stop the Generator but in a controlled manner. On initiation of the electrical trip condition the module will de-energies the '**Close Generator**' Output to remove the load from the generator.

For example,

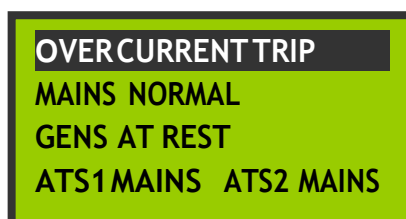

No.	DISPLAY	RANGE	REASON
1	GENERATOR OVER CURRENT	Always active	If a generator output in excess of pre-setting current, a warning alarm occurs. If this condition continues for an excess period, then the alarm escalates to electrical trip shutdown.
2	AUXILIARY INPUTS (1-6)	User defined	If the auxiliary input configured as an electrical trip is active, the appropriate message will be displayed as defined by the user.

Note: Types of input trip alarm quantity must be configured by users, and then input port is active.

5.4 AUTOMATIC START CONDITIONS OF ENGINE

Controller will execute start program when the following conditions are met.

No.	Condition	Description
1	Mains Abnormal	When controller detects mains abnormal (voltage, frequency and loss of phase have exceeded user defined threshold), it will start.
2	Remote Start active	When controller detects active remote start signal, it will start.
3	Ambient Over Temp.	When controller detects temperature of engine room over the pre-set, it will start.
4	Pile Under Volt	When controller detects the voltage of Pile below the pre-set, at the same time, mains abnormal or remote start active, it will start.
5	Cycle Run Start	When cycle running start timer is due, it will start.
6	Scheduled Start	When scheduling start timer is due, it will start.

Note : 1. Start inhibit is inactive.
2. If any condition is met, the engine can be started.

5.5 AUTOMATIC STOP CONDITIONS OF ENGINE

When mains normal or remote start inactive, engine will stop normally.

When mains abnormal or remote start active, engine will also stop normally if the following conditions are met.

No.	Condition	Description
1	Ambient Temp Low	When engine start, the room temperature turns normal, and it will stop.
2	Pile Over Volt	When engine start, battery voltage turns normal, and it will stop.
3	Low Load Current	When switch power is electrified, but current is less than the pre-set minimum limit and room temperature is not high, it will stop.

4	Cycle Run Stop	When cycle running stop timer is due, it will stop.
5	Scheduled Run Stop	When scheduling running timer is due, it will stop.
6	Battery Charge Completion	After battery charging is completed, controller will execute stop.

5.6 AIR-CONDITIONING ATS ACTIONS

No.	Condition		Description	
1	High Ambient Temp.	Mains normal	air conditioning ATS switches to mains, priority ATS switches to mains	
2		Mains abnormal	battery charge duration over the pre-set	air conditioning ATS switches to gens, priority ATS switches to gens
3			switch power current below the pre-set	air conditioning ATS switches to gens, priority ATS switches to gens

5.7 GSM MESSAGE ITEMS

No.	Condition	Description
1	High Water Temp. Warn	Selectable
2	Low Oil Pressure Warn	Selectable
3	Over Speed Warn	Selectable
4	Under Speed Warn	Selectable
5	High Volt Warn	Selectable
6	Low Volt Warn	Selectable
7	Failed To Stop Warn	Selectable
8	Low Fuel Level Warn	Selectable
9	Charge Failure Warn	Selectable
10	Low Battery Volt	Selectable
11	Control Gate Open	Selectable
12	Control Gate Close	Selectable
13	Low Pile Volt	Selectable
14	Emergency Stop	Selectable
15	High Temp. Shutdown	Selectable
16	Low Oil Pressure Stop	Selectable
17	Over Speed Shutdown	Selectable
18	Under Speed Shutdown	Selectable
19	Loss Of Speed Shutdown	Selectable
20	High Freq. Shutdown	Selectable

21	Low Freq. Shutdown	Selectable
22	High Volt Shutdown	Selectable
23	Low Volt Shutdown	Selectable
24	Over Current Shutdown	Selectable
25	Failed To Start	Selectable
26	Pressure Sensor Open	Selectable
27	Aux. Input1-6 Shutdown	Selectable
28	Mains Normal	Selectable
29	Mains Abnormal	Selectable
30	Be Out Auto Mode	Selectable
31	Generator Cranking	Selectable
32	Ambient Temp High	Selectable
33	Ambient Temp High Warn	Selectable
34	Generator Stop	Selectable
35	ATS 1 To Gens	Selectable
36	ATS 1 To Mains	Selectable
37	ATS 2 To Gens	Selectable
38	ATS 2 To Mains	Selectable
39	Generator Alarm Shutdown	Selectable
40	SMS Enabled	Selectable
41	SMS Disabled	Selectable

5.8 GSMSHORT MESSAGE CONTROL

User sends short messages to GSM module, and then controller will execute corresponding actions according to the instructions, at the same time to send back the executive information.

No.	INSTRUTION	RETURNED MESSAGE	DESCRIPTION
1	SMS GENSET	GENSET ALARM	Generator shutdown alarm or electrical trip alarm
		SYSTEM IN STOP MODE GENSET AT REST	In stop mode, standby statuses
		SYSTEM IN MANUAL MODE GENSET AT REST	In manual mode, standby statuses
		SYSTEM IN TEST MODE GENSET AT REST	In test mode, standby statuses
			Receiving status

		SYSTEM IN AUTO MODE GENSET AT REST	In auto mode, standby statuses	
		SYSTEM IN STOP MODE GENSET IS RUNNING	In stop mode, genset start	
		SYSTEM IN MANUAL MODE GENSET IS RUNNING	In manual mode, genset start	
		SYSTEM IN TEST MODE GENSET IS RUNNING	In test mode, genset start	
		SYSTEM IN AUTO MODE GENSET AT RUNNING	In auto mode, genset start	
2	SMS START	GENSET ALARM	Generator shutdown alarm or electrical trip alarm	crank
		STOP MODE NOT START	in stop mode, genset not start	
		SMS START OK	In manual/test mode, genset crank	
		AUTO MODE NOT START	In auto mode, genset not start	
3	SMS STOP MODE	SMS STOP OK	Set controller as stop mode	
4	SMS MANUAL MODE	SMS MANUAL MODE OK	Set controller as manual mode	
5	SMS TEST MODE	SMS TEST MODE OK	Set controller as test mode	
6	SMS AUTO MODE	SMS AUTO MODE OK	Set controller as auto mode	
7	SMS DETAIL	Returned information can be configured by PC	Receiving messages	

NOTE: 1. SMS DETAIL returned information including working mode, mains voltage, gens voltage, load current, mains frequency, gens frequency, active power, apparent power, power factor, battery voltage, D+ voltage, water temperature, oil pressure, fuel level, rotating speed, accumulated run time, genset status, Pile voltage, engine room temperature, ATS status, alarm status.

2. If using SMS DETAIL to obtain the information in Chinese, please change the description to that of combined by letters or digital numbers, otherwise, unreadable codes will occur.

5.9 MAINS ELECTRIFY RULES

User can set the rules of mains on actual using demands.

No.	Rules description	
1	Phase A must be electrified	both Phase B and phase C with phase
2		Either Phase B or phase C loses phase
3		both Phase B and phase C lose phase
4	Phase B NOT	3 Phase can lose 1 phase
5		3 Phase can lose 2 phase

5.10 EVENT LOG ITEMS











When the following conditions happen, controller will save these alarm records for event viewing. Max accumulated 200 pieces of alarm records.

No.	ITEMS
1	Emergency stop shutdown
2	High water temp. shutdown
3	Low oil pressure shutdown
4	Gens over speed shutdown
5	Gens under speed shutdown
6	Loss of speed signal shutdown
7	Gens over freq. shutdown
8	Gens under freq. shutdown
9	Gens over volt shutdown
10	Gens under volt shutdown
11	Gens over current shutdown
12	Fail to start shutdown
13	Oil pressure sensor open circuit shutdown
14	Aux. input 1 shutdown
15	Aux. input 2 shutdown
16	Aux. input 3 shutdown
17	Aux. input 4 shutdown
18	Aux. input 5 shutdown
19	Aux. input 6 shutdown
20	Over current trip
21	Aux. input 1 electrical trip
22	Aux. input 2 electrical trip
23	Aux. input 3 electrical trip
24	Aux. input 4 electrical trip
25	Aux. input 5 electrical trip
26	Aux. input 6 electrical trip
27	Maintenance time due shutdown
28	Oil pressure 2 low shutdown

29	Oil pressure low shutdown
30	Water temp. high input alarm
31	Oil pressure low alarm
32	Oil temp. high input alarm
33	Cylinder temp. high input alarm
34	Water level low input alarm
35	Fuel level low input alarm
36	Over speed input alarm
37	External input alarm
38	Over current input alarm
39	Half-fuel level input alarm

6 PANEL SETTING

6.1 PARAMETER EDITING

1. Press , enter into parameter configuration password interface;
2. Press  or  to input right password (rang of 0-9), press  to shift bit right and confirm. If password correct, enter main menu; if not, exit directly. Default password is **1234** which can be defined.
3. Press  or  to scroll the screen and  to enter the chosen item. Press  or  to edit the value, and press  to shift bit right and confirm. If setting value is within the range, it'll be saved in internal FLASH forever.

Note: During editing, pressing  at any time can exit the editor and back to the standby status.

No.	Items	Range	Default	Note
1	SMS Enabled	(0-1)	0	0: Close; 1: Open
2	Pile Volt Over	(0~+100.0)V	58.0V	The voltage when charging is finished, which allows stopping generator.
3	Pile Volt Under	(0~+100.0)V	45.0V	Battery patch under voltage threshold.
4	Ambient Over Temp	(0~60)°C	28°C	Temperature of engine room high threshold.
5	Ambient Under Temp	(0~60)°C	22°C	Allowed temperature in stopping.
6	Load Current	(0~100)%	15%	Allowed load current in stopping.
7	Charge Lowest Time	(5-360)m	30m	Wait to crank delay of air-conditioning.
8	Cycle Run Start Time	(0~600)m	0m	Gens normal cycle running time. When time is up,

No.	Items	Range	Default	Note
				engine will stop.
9	Cycle Run Stop Time	(0~600)m	0m	Gens normal cycle stopping time. When time is up, engine will start.
10	Not Start Time	(0~720)m	480m	Engine"s at rest time at night.
11	Not-Start Start time	00:00~23:59	22:00	
12	Low Fuel Level Warn	(0-100)%	10%	
13	Start Delay	(0-9999)s	5s	
14	Pre-Heat Delay	(0-300)s	0s	
15	Cranking Time	(3-60)s	8s	
16	Crank Rest Time	(3-60)s	10s	
17	Safety On Delay	(5-60)s	10s	
18	Start Idle Delay	(0-3600)s	10s	
19	Warming Up Delay	(0-3600)s	30s	
20	Return Delay	(0-9999)s	30s	
21	Cooling Delay	(0-3600)s	60s	
22	Stop Idle Delay	(0-3600)s	10s	
23	ETS Delay	(0-120)s	20s	
24	Fail To Stop Delay	(10-120)s	30s	
25	Gens Transient	(0-30)s	5s	
26	Over Current	(0~120)%	100% (500A)	
27	Mains Under Volt Trip	(50-360V/624)*1	184V	
28	Mains Over Volt Trip	(50-360V/624)*1	276V	
29	Gens Under Volt Stop	(50-360V/624)*1	184V	
30	Gens Under Volt Warn	(50-360V/624)*1	196V	
31	Gens Over Volt Warn	(50-360V/624)*1	265V	
32	Gens Over Volt Stop	(50-360V/624)*1	273V	
33	Battery Under Volt Warn	(0-39.9)V	8.0V	
34	Battery Over Volt Warn	(0.1-40)V	33.0V	
35	Fuel Pump Open	(0~100)%	25%	
36	Fuel Pump Close	(0~100)%	75%	
37	Tel Number 1	Max. 16 bit		No space between the numbers;
38	Tel Number 2			

No.	Items	Range	Default	Note
39	Tel Number 3			Add national phone code before the number.
40	Password	(0-9999)	1234	Digital number
*1 NOTE : 360V Is Phase Voltage, 624V Is Line Voltage (3 Phase 3 Wire) .				

Other parameters configuration: They can be only configured via PC software (as follows).

No.	Item	Description
1	Module Address	1
2	Crank Times	3
3	Normal/Fast Start Mode Select	Normal
4	Electrify Mode Set	Stop mode
5	OP1 Sensor Type	VDO 10Bar
6	OP1 Sensor Curve	
7	Temp. Sensor Type	VDO 120 degrees C
8	Temp. Sensor Curve	
9	Fuel Level Sensor Type	VDO Ohm Range(10-180)
10	Fuel Level Sensor Curve	
11	Digital Input 1	Remote start on load, close to activate.
12	Digital Input 2	Control gate signal input, close to activate.
13	Digital Input 3	Low oil pressure input, shutdown, close to activate (from safety on over).
14	Digital Input 4	Low oil level input, warning, close to activate, (always activate).
15	Digital Input 5	High oil temperature input, shutdown, close to activate (from safety on over).
16	Digital Input 6	External alarm input, shutdown, close to activate (always activate).
17	Digital Output 1	From pre-heat output to start
18	Digital Output 2	Common alarm
19	Digital Output 3	ETS solenoid output
20	Digital Output 4	Idle /High speed control
21	Digital Output 5	Air-conditioning ATS control
22	Digital Output 6	Priority ATS control





23	LED1	System in Auto mode
24	LED2	Fail to start
25	LED3	Common shutdown alarm
26	LED4	Common alarm
27	OP1 Warn Return	138kPa
28	Temp. Warn Return	88°C
29	Battery Volt Low Delay	60s
30	Battery Volt High Delay	60s
31	Maintenance Time	300
32	Maintenance Set	Disable
33	Mains Under Volt Return	207V
34	Mains Over Volt Return	253V
35	Mains Under Freq. Return	48.0Hz
36	Mains Over Freq. Return	52.0Hz
37	Gens On-Load Volt	207V
38	Gens Over Volt Return	253V
39	Gens On-Load Freq.	45.0Hz
40	Gen Over Freq. Return	52.0Hz
41	CT Preliminary Current	500A
42	Load Current	500A
43	Time Multiplier	36
44	Over Current Action	Trip shutdown
45	Gens Freq. Of Crank Disconnect	15Hz
46	Gens Speed Of Crank Disconnect	450RPM
47	Gens Oil Pressure Of Crank Disconnect	200kPa
48	Gens Under Speed Return	1380 RPM
49	Gens Over Speed Return	1620RPM
50	Loss Of Speed Signal	Stop
51	Battery Under Volt Return	9.0V

52	Battery Over Volt Return	32.0V
53	Crank Disconnect Condition	Frequency + magnetic pickup
54	Start Condition Select	2, 4, 5, 6 (will not start when mains abnormal)
55	Starting Oil Pressure Detect	Not used
56	Volt Transformer Preliminary	100
57	Volt Transformer Second	100
58	Scheduled Run Select	Disable
59	Scheduled Run Week	
60	Scheduled Run Start	
61	Scheduled Run Duration	
62	Controller Electrify Mode	Stop mode
63	SMS Message	
64	Genset Description	Chinese and English information can be input in Chinese interface; Only English can be put in English interface
65	Alarm Number 4	No space between numbers;
66	Alarm Number 5	Add national phone code before the number.
67	Mains Transient Delay	2s
68	Gens Under Freq. Shutdown	40.0Hz
69	Gens Under Freq. Warn	42.0 Hz
70	Gens Over Freq. Warn	55.0 Hz
71	Gens Over Freq. Shutdown	57.0 Hz
72	Number Of Flywheel Teeth	118
73	Gens Under Speed Shutdown	1270RPM
74	Gens Under Speed Warn	1350 RPM
75	Gens Over Speed Warn	1650 RPM
76	Gens Over Speed Shutdown	1710 RPM
77	Speed Overshoot Percentage	0
78	Charge Failure Warn	6.0V

79	OP2 Sensor Type	Not used
80	OP 2 Sensor Curve	
81	Ambient Temp. Sensor Type	PT 100
82	Ambient Temp. Sensor Curve	
83	Low OP 2 Pre-Alarm	124 kPa
84	Low OP 2 Shutdown	103 kPa
85	Low OP 2 Warn Return	138 kPa
86	Ambient High Temp.	40°C
87	Poles Number	4
88	Mains AC Power Supply	3 phase 4 wire
89	Gens AC Power Supply	3 phase 4 wire
90	Mains Electrify Rule	ABC cannot be in loss of phase
91	SMS Alarm Set	
92	Mains Under Freq. Trip	45.0Hz
93	Mains Over Freq. Trip	55.0 Hz
94	Low Oil Pressure1 Warn	124kPa
95	Low OP 1 Shutdown	103 kPa
96	High Water Temp. Warn	90°C
97	High Water Temp. Shutdown	95°C
98	Over Speed Delay	2s
99	Charge Completion Time	720m

Note: scheduled run means timely to start and stop the genset.

6.2 DATE AND TIME SETTING

1. Press , enter the setting interface. (See the fig) The first line is real time, and second line is for user setting.
2. Press  or  to change the value, and  to shift bit right and confirm.  will exit directly but not save the setting.

Note: Setting sequence: year-month-day (week) hour-minute-second.

7 DEFINITION OF INPUTS AND OUTPUTS

7.1 DEFINITION OF AUX. INPUT 1-6

Type	DESCRIPTION
User Defined	User can define the following functions Indication: only state display, no alarm or shutdown. Warning: only warning, no shutdown. Shutdown: alarm, even immediately shutdown. Electrical Trip: alarm/generator off-load, shutdown after high speed cooling Inactive: input is inactive. Always active: input is always detected. Active after start: The controller begins detecting once started. Active in safety run on: The controller begins detecting after safety on delay.
Alarm Mute	When the input is active, can prohibit output configurable within "Alarm mute" output.
Alarm Reset	When the input is active, can reset stop alarm and electrical trip alarm.
Control Gate Input	When the access switch is opened, alarm signal is initiated.
Reserved	
Mains Abnormal Auxiliary Input	When the input is active, display mains abnormal.
Reserved	
Reserved	
Lamp Test	When the input is activated all LED indicators will illuminate.
Reserved	
Reserved	
Panel Lock	When the input effective, not all keys on its function, on the first screen LCD panel display  on the line.
Remote Start (With Load)	In automatic mode, when the input effective, can automatically open generator, after the normal operation of generator with load. When the input is invalid, can automatically stop generator.
Remote Start (Off Load)	In automatic mode, when the input effective, can automatically open generator, after the normal operation of generator without load. When the input is invalid, can automatically stop generator.
Inhibit Scheduled Start	In automatic mode, this will inhibit the engine to scheduled run.
Reserved	

Note: Auxiliary input 1-6 can only be configured via PC software.

7.2 DEFINITION OF AUX. OUTPUT 1-6

No.	Type	DESCRIPTION
1	Not Used	
2	Air Flap Control	When over speed alarm shutdown and emergency stop is active, can turn off air flap.
3	Audible Alarm	When warning, shutdown, electrical trip is active, can connect exterior alarm, can configure input port "Audible alarm".
4	Battery High Voltage	The DC supply has risen above the high volts setting level for the duration of the high battery volts timer
5	Battery Low Voltage	The DC supply has fallen below the low volts setting level for the duration of the low battery volts timer
6	Fan Control	When room temperature exceeds the setting threshold, open the fan. When below the pre-setting, close the fan.
7	GSM Error	GSM module cannot be communicated with.
8	GSM Power Control	Control GSM module power. When GSM fails, restart GSM.
9	Crank Relay Output	Operation of generator start, disconnect after start success.
10	Fuel Relay Output	When generator start is active, disconnect of waiting stop steady.
11	Scheduled Start Enable	The controller operates when scheduler start is active, or inactive.
12	Charge Failure	The controller is active when generator charges failure alarm.
13	ATS 2 Control	Used for spare ATS switching.
14	Reserved	
15	ATS 1 Control	Used for priority ATS switching.
16	Reserved	
17	Common Under/Over Freq Shutdown	Either under frequency or over frequency shutdown has been activated.
18	Common Under/Over Freq Warn	Either under frequency or over frequency warning has been activated.
19	Common Under/Over Volt Shutdown	Either under voltage or over voltage shutdown has been activated.
20	Common Under/Over Volt Warn	Either under voltage or over voltage warning has been activated.
21	Common Alarm	A warning, electrical trip or shutdown alarm has been activated. Reset rules as above, depending on whether it is a warning or a shutdown fault.
22	Common Electrical Trip Alarm	An electrical trip alarm has been activated. This output can only be reset by removal of the fault and by then

No.	Type	DESCRIPTION
		pressing the stop reset button.
23	Common Shutdown Alarm	A shutdown alarm has been activated. This output can only be reset by removal of the fault and by then pressing the stop reset button or by using an external „Alarm Reset“ Input.
24	Common Warn Alarm	A warning alarm has been activated. This output is normally self-resetting on removal of the fault. However, it is possible to configure the module such that the warning alarms are.
25	High Water/Cylinder Temp. Warn	Action when water/cylinder temperature high warns.
26	High Water/Cylinder Temp. Shutdown	Action when water/cylinder temperature high alarms.
27	Cooling Delay	Action during cooling delay
28	Reserved	
29	Digital Input 1 Active	Action when digital input 1 is active.
30	Digital Input 2 Active	Action when digital input 2 is active.
31	Digital Input 3 Active	Action when digital input 3 is active.
32	Digital Input 4 Active	Action when digital input 4 is active.
33	Digital Input 5 Active	Action when digital input 5 is active.
34	Digital Input 6 Active	Action when digital input 6 is active.
35	Emergency Stop Alarm	An emergency stop alarm has occurred.
36	ETS Solenoid Shutdown Output	This output controls the fuel solenoid on an ETS solenoid type generator, energizing for the time period selected in the Edit Timer Menu. The normal fuel output (pin 4) should not be connected to the fuel solenoid, however it can be used for controlling panel instruments and other functions required whilst the engine is running.
37	Fail To Start Alarm	The engine has not started after the specified number of attempts, selected in the edit miscellaneous menu.
38	Fuel Pump Control	This output is used to control a fuel transfer pump. Once the „fuel pump on“ level has been reached the module will activate the fuel pump control output. This output will remain active until the „fuel pump off“ level is reached.
39	Gens Valid	This output indicates when the generator is ready to accept load, i. e. after safety on and warm up timers have timed out. It could be used to connect to an automatic transfer system or PLC to give a signal that the set is available.
40	Gens Over Freq Warn	This output indicates that a generator high frequency warning (pre- alarm) has occurred.

No.	Type	DESCRIPTION
41	Gens Over Freq Shutdown	This output indicates that a generator high frequency shutdown has occurred.
42	Gens Over Volt Warn	This output indicates that a generator high voltage warning (pre- alarm) has occurred.
43	Gens Over Volt Shutdown	This output indicates that a generator high voltage shutdown has occurred.
44	Gens Under Freq. Warn	This output indicates that a generator low frequency warning (pre- alarm) has occurred.
45	Gens Under Freq. Shutdown	This output indicates that a generator low frequency shutdown has occurred.
46	Gens Under Volt Warn	This output indicates that a generator low voltage warning (pre- alarm) has occurred.
47	Gens Under Volt Shutdown	This output indicates that a generator low voltage shutdown has occurred.
48	Louvre Control	This output controls the opening of the louvers on engine starting and closure when engine has stopped.
49	Low Fuel Level	This output indicates that the level of fuel has fallen below the low fuel alarm trip point.
50	Loss Of Speed	This output indicates that a loss of speed alarm has occurred.
51	Mains Abnormal	This output indicates that the module has sensed that a failure of the incoming AC mains supply. This output will become active whenever the mains voltage or frequency goes out of limits, or if the auxiliary mains failure input active (if used) and the mains transient timer has expired.
52	Mains High Freq	This output indicates that the module has sensed that the incoming AC mains supply has exceeded the frequency limit setting.
53	Mains Over Voltage	This output indicates that the module has sensed that the incoming AC mains supply voltage has exceeded the voltage limit setting.
54	Mains Under Freq	This output indicates that the module has sensed that the incoming AC mains supply has fallen below the frequency setting.
55	Mains Under Voltage	This output indicates that the module has sensed that the incoming AC mains supply voltage has fallen below the voltage limit setting.
56	Low OP Warn	The controller is active when low oil pressure 1 warning.
57	Low OP Shutdown	The controller is active when low oil pressure 1 shutdown.
58	OP Sensor Open	This output indicates that the module has detects an open circuit failure in the Oil Pressure transducer circuit.

No.	Type	DESCRIPTION
59	ATS to Mains	Mains on load
60	ATS to Gens	Gens on load
61	Reserved	
62	Reserved	
63	Over Current Warn	This output indicates that the over-current warning (pre-alarm) level has been reached.
64	Over Current Trip	This output indicates that the over-current trip level been reached.
65	Over Speed Warn	This output indicates that an over speed warning (pre-alarm) has occurred.
66	Over Speed Shutdown	This output indicates that an over speed shutdown has occurred.
67	Pre-Heat (During Starting Timer)	This output controls the pre-heater. Pre-heat output is available for the duration of the pre-heat timer, which terminates prior to cranking.
68	Pre-Heat (Until End Of Cranking)	This output controls the pre-heater. As „Pre-heat (during preheat timer)” mode but pre-heat is also available during cranking.
69	Pre-Heat (Until End Of Warming)	This output controls the pre-heater. As “Pre-heat (until safety on)” but pre-heat continues to be available until the warm-up timer has elapsed
70	Pre-Heat (Until End Of Safety Run)	This output controls the pre-heater. As „Pre-heat (until end of cranking)” but pre-heat is also available while waiting for the delayed alarms to become active.
71	Reserved	
72	System In Manual Test Mode	This output indicates that the module is in the manual test mode.
73	System In Auto Mode	This output indicates that the module is in the automatic mode.
74	System In Manual Mode	This output indicates that the module is in the manual mode.
75	System In Stop Mode	This output indicates that the module is in the stop mode.
76	Under Speed Warn	This output indicates that an under speed warning (pre-alarm) has occurred.
77	Under Speed Shutdown	This output indicates that an under speed shutdown has occurred.
78	Reserved	
79	Idle/ High Speed Control	This output is active from cranking, continues to be active until the start idle time has elapsed; Also this output is active during the period of the stop idle timer, and continues to be active until the engine has stopped.

No.	Type	DESCRIPTION
80	Pre-Oil Supply Output	This output is active during start- safety running.
81	Raise Speed Output	This output is active during the warming up timer.
82	Charge Excitation Output	Starting in the safe operation of the output, in no power frequency is output during the 2 seconds.
83	Droop Speed Output	This output is available during the period of the coolant down timer, and remain until the engine has stopped.
84	Oil Lubrication Output	This output is active during pre-heat safety running.
85	Ambient Temp High Warn	Alarm when the temperature of engine room reaches the warn value.
86	Reserved	
87	Low OP 2 Warn	
88	Low OP 2 Shutdown	

Note: Output port 1-6 only can configured via PC software.

8. EVENT LOG VIEWING

Controller can save 200 pieces of shutdown records (warnings won't be saved), which include type, date and time of abnormal shutdown. Once up to 200, next new abnormal shutdown will replace the oldest one for refreshing the whole event log.

Press  key to enter into event menu, choose the event record, and then view the event log. (See the below fig)

Press  or  scroll the records, and press  key to exit directly.

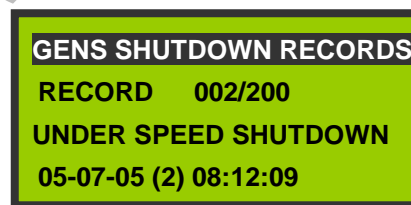
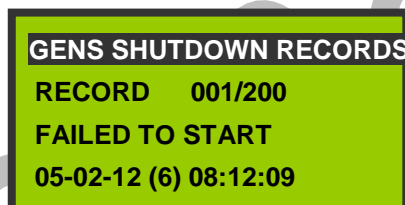

9. COMMISSIONING

Please make the under procedures checking before commissioning,

1. Check all the connections are correct and wires diameter is suitable.
2. Ensure that the controller DC power has insurance, controller's positive and negative connected to start battery are correct.
3. Scram button's normal close point is connected with emergence stop input, and insurance must be connected with positive and negative of start battery.
4. Take proper actions to prevent engine to start successfully (e. g. Remove the connection wire of fuel valve). If checking is OK, make the start battery power on.

5. Set controller under manual mode, press “start” button, genset will start. After the setting crank times, controller will send signal of Fail to Start; then press “Reset” to make controller as reset.
6. Recover the action of Fail to Start (e. g. Connect wire of fuel value), press “start” button again, genset will start. If everything goes well, genset will normal run after idle running (if configured). During this period, please watch for engine’s running situations and AC generator’s voltage and frequency. If abnormal, stop genset and check all wires connection according to this manual.
7. Select the **AUTO** mode from controller’s panel, connect to mains signal. After the mains normal delay, controller will transfer ATS (if have) and into mains load. After cooling time, controller will stop genset and into standby state until mains abnormal again.
8. When mains abnormal again, genset will start automatically and into normal running, sends signal to make gens switch on, and control ATS to switch to load. If not like this, please check ATS” wires connection according to this manual.
9. If there are any other questions, please contact Smartgen”s technical personnel.

10. REAR PANEL

The back panel of **HGM6320T** controller is shown as below,

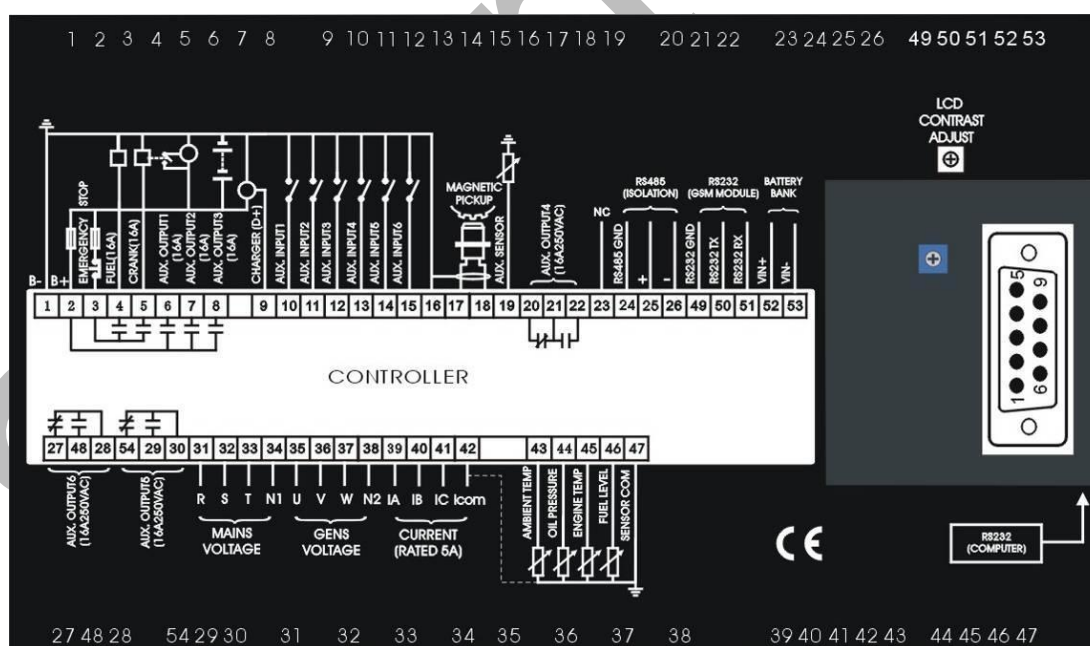

PIN	FUNCTION	DIAMETER	DESCRIPTION
1	DC Plant Supply Input (B-)	2.5mm ²	System DC negative input. Connect to battery negative.
2	DC Plant Supply Input (B+)	2.5mm ²	System DC positive input. Connect to battery positive. (Recommended fuse 20A)

PIN	FUNCTION	DIAMETER	DESCRIPTION
3	Emergency Stop Input	2.5mm ²	Plant supply B+. Also supplies fuel and start outputs. (Recommended fuse 30A)
4	Fuel Output Relay	2.5mm ²	Plant supply B+ from pin 3. 16 Amp rated.
5	Start Output Relay	2.5mm ²	Plant supply B+ from pin 3. 16 Amp rated.
6	Aux. Output 1	2.5mm ²	B+ output. 16 Amp rated.
7	Aux. Output 2	2.5mm ²	B+ output. 16 Amp rated.
8	Aux. Output 3	2.5mm ²	B+ output. 16 Amp rated.
9	Charge Failure / Excitation	1.0mm ²	Alternator D+ input, do not connect to ground. Offer excitation for charging alternator.
10	Aux. Input 1	1.0mm ²	Switch to B-
11	Aux. Input 2	1.0mm ²	Switch to B-
12	Aux. Input 3	1.0mm ²	Switch to B-
13	Aux. Input 4	1.0mm ²	Switch to B-
14	Aux. Input 5	1.0mm ²	Switch to B-
15	Aux. Input 6	1.0mm ²	Switch to B-
16	Magnetic Common GND	1.0mm ²	Connect to GND. Can connect to shell or start battery negative.
17	Magnetic Pickup B +	1.0mm ²	Connect to magnetic pickup device.
18	Magnetic Pickup B-	1.0mm ²	
19	Oil Pressure Sensor 2	1.0mm ²	Oil pressure sensor input. External connect to resistance type sensor.
20	Aux. Output 4	2.5mm ²	Free relay contacts. 16Amp rated.
21			
22			
23	Not Connected		
24	RS485 Common GND	Screen	Opto-isolation, used for remote monitoring and parameter configuration. Screen single grounded.
25	RS485 +	0.5mm ²	
26	RS485 -	0.5mm ²	
27	Aux. Output 6	2.5mm ²	Control ATS switch, Free voltage contacts, 16 Amp rated.
28			
48			
54	Aux. Output 5	2.5mm ²	Control ATS switch, Free voltage

PIN	FUNCTION	DIAMETER	DESCRIPTION
30	(Close Generator Output)		contacts, 16 Amp rated.
29			
31	Mains Phase A Volt Sensing	1.0mm ²	Connect to mains A output (Recommend 2A fuse)
32	Mains B Volt Sensing	1.0mm ²	Connect to mains B output (Recommend 2A fuse)
33	Mains C Volt Sensing	1.0mm ²	Connect to mains C output (Recommend 2A fuse)
34	Mains Neutral Input	1.0mm ²	Connect to mains neutral terminal
35	Generator A Volt Sensing	1.0mm ²	Connect to generator A output (Recommend 2A fuse)
36	Generator B Volt Sensing	1.0mm ²	Connect to generator B output (Recommend 2A fuse)
37	Generator C Volt Sensing	1.0mm ²	Connect to generator C output (Recommend 2A fuse)
38	Generator Neutral Input	1.0mm ²	Connect to generator N line terminal.
39	CT Secondary A Sensing	2.5mm ²	Connect to secondary of A (maximum 5A)
40	CT Secondary B Sensing	2.5mm ²	Connect to secondary of B (maximum 5A)
41	CT Secondary C Sensing	2.5mm ²	Connect to secondary of C (maximum 5A)
42	CT Secondary Common	2.5mm ²	Common GND, connecting to start battery negative.
43	Ambient Temp Sensor Input	1.0mm ²	The temperature sensor input, external connecting to resistance sensor.
44	Oil Pressure Sensor Input	1.0mm ²	Oil pressure sensor input, external connecting to resistance sensor.
45	Engine Temp Sensor Input	1.0mm ²	Cooling sensor input, external connecting to resistance sensor.
46	Fuel Quantity Sensor Input	1.0mm ²	Fuel quantity sensor input, external connecting to resistance sensor.
47	Sensor Common	1.0mm ²	Sensors common GND can connect to shell or start battery negative.
49	RS232 Common	Screen	Communication with GSM module (2-RXD, 3-TXD, 5-GND), screen single grounded.
50	RS232 TXD	0.5mm ²	
51	RS232 RXD	0.5mm ²	
52	Pile Volt VIN+	1.0mm ²	Connect to battery positive.
53	Pile Volt VIN-	1.0mm ²	Connect to battery negative.
COM	RS 232	Multi-strands screen	Remote monitoring and parameter configuration, standard DB9 interface.
LCD	LCD Contrast Adjust		When LCD backlit is improper, adjust the potentiometer.

11 COMMUNICATION

Serial port: RS485/RS232

Communication protocol: MODBUS

Baud rate: 9600

Data Bits: 8

Parity: none

Stop bit: 1-2 bits

Communication address: 1-254

Please refer to **HGM6320T Communication Protocol** for details.

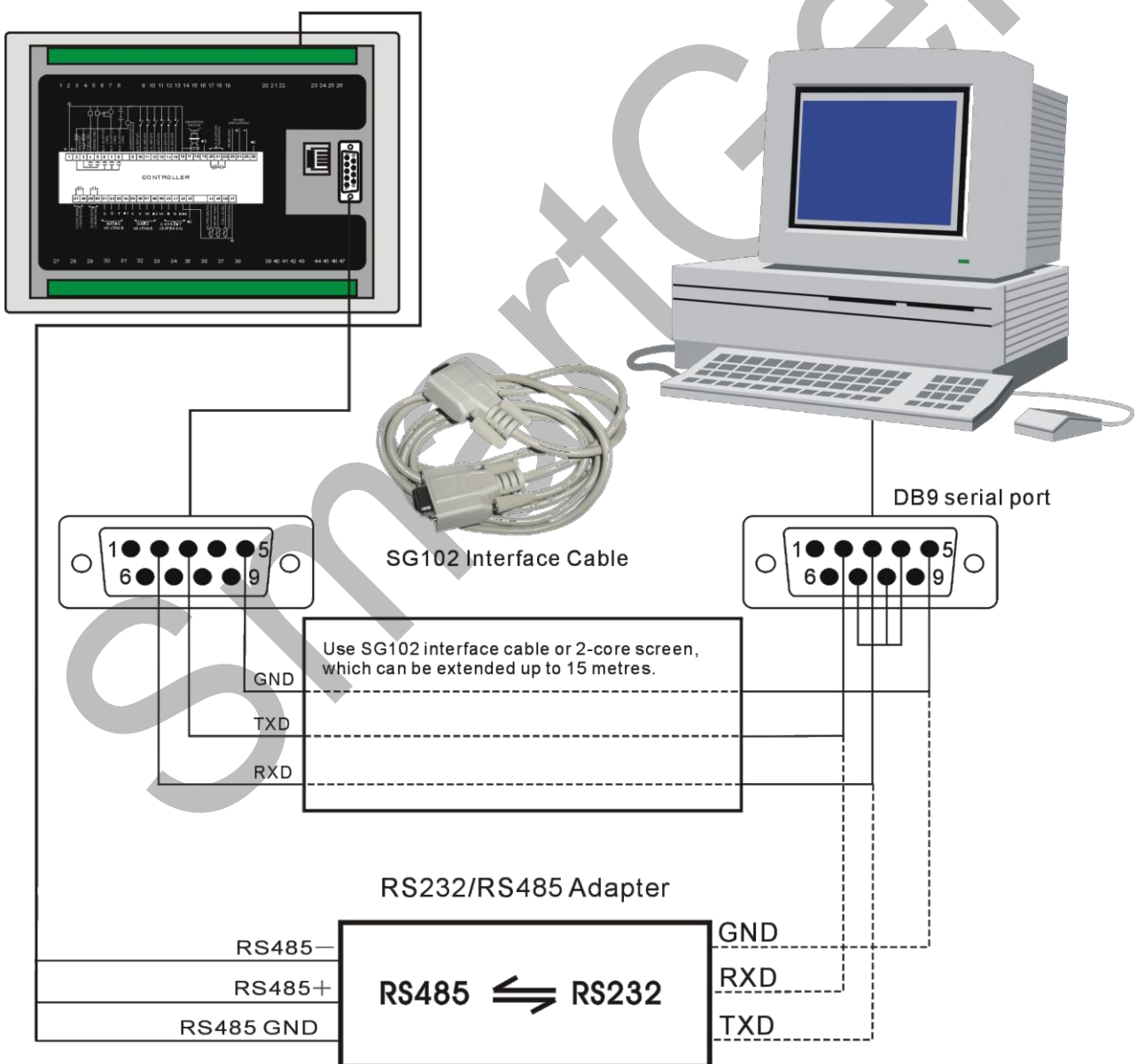

12 TYPICAL WIRING DIAGRAMS

HGM6320T Typical wiring diagram

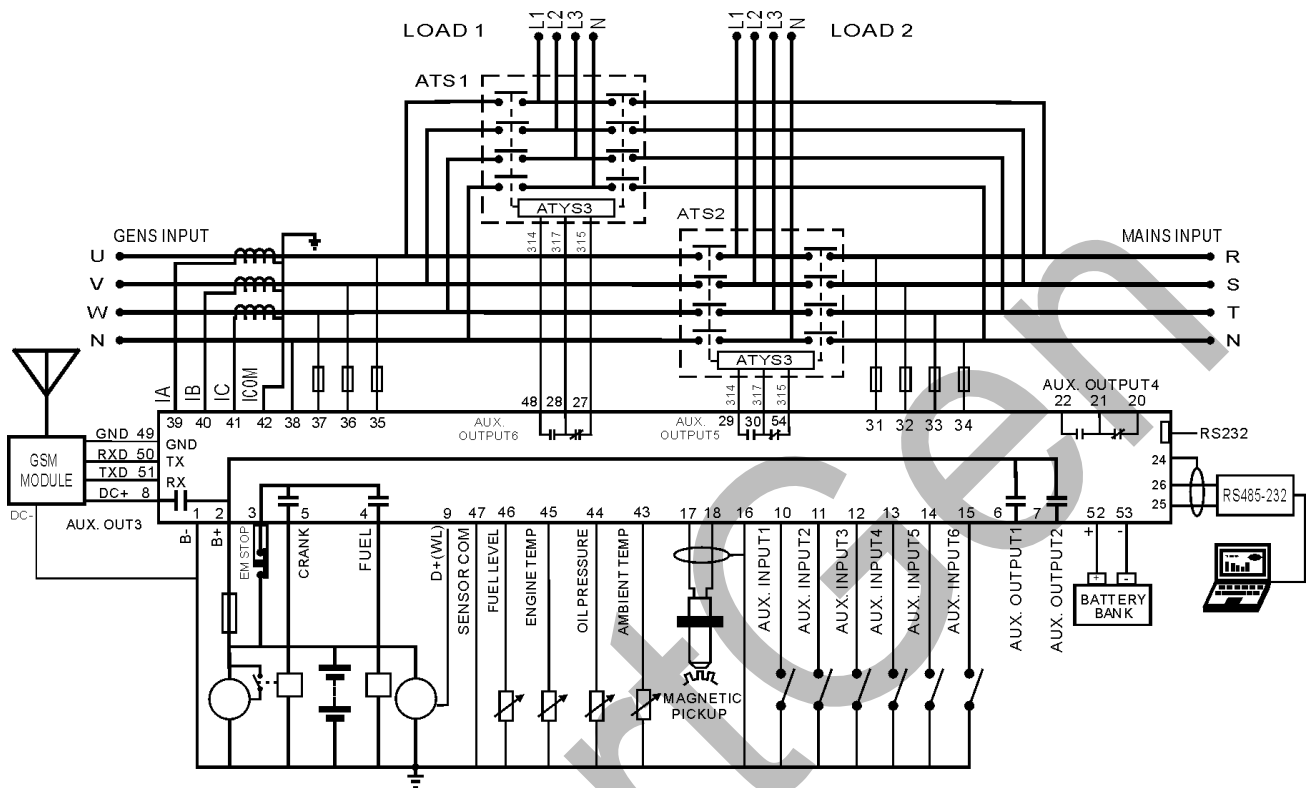

Note :

- 1) Connect GSM MODEM with RS232 according to above diagram. DC+ of GSM module can be connected auxiliary output 3 (or other outputs). Set this port as "GSM power", and connect DC- to B- terminal. When GSM module crashes or cannot work because of other internal problems, controller will disconnect GSM power supply once to reset normal operation.
- 2) If the voltage of starter battery is 24V, battery negative resistance of start output, fuel output and stop output (according to user configuration) should not be less than 2Ω. If less than 2Ω, please expand a relay of over 30A current in the output ports. If the voltage is 12V, battery negative resistance should not be less than 1Ω. If less than 1Ω, please expand a relay of over 30A current in the outputs.

13 FAULT FINDING

SYMPTOM	POSSIBLE REMEDY
Controller Is Inoperative	Check the start battery and wiring to the unit. Check the DC supply and fuse.
Genset Shutdown	Check the engine temperature is not over the pre-set; Check the AC supply voltage; Check the DC fuse.
Controller Emergency Stop	If Emergency Stop is not fitted, ensure that a DC positive signal is connected to the Emergency Stop input. Check emergency stop switch is enabled. Wiring is not open circuit.
Low Oil Pressure After Engine Has Fired	Check engine oil pressure. Check oil pressure switch/sensor and wiring.
High Engine Temp After Engine Has Fired.	Check engine temperature. Check switch/sensor and wiring.
Shutdown During Running	Check relevant switch and wiring. Check inputs configuration.
Fail To Start	Check wiring of fuel solenoid. Battery supply is present on the fuel output of the module. Check the speed-sensing signal is present on the module's inputs. (Refer to engine manual)
Starter Motor Is Inoperative	Check wiring to starter solenoid. Check battery supply is present on the starter output of module.
Engine Runs But ATS Not Switch	Check ATS Check the connections between controller and ATS. Check if fitted with gens inhibit or mains load input.
Auxiliary Input Alarm	Check the inputs wiring. Check if input polarity is fitted correctly.

14 OVER CURRENT CURVE

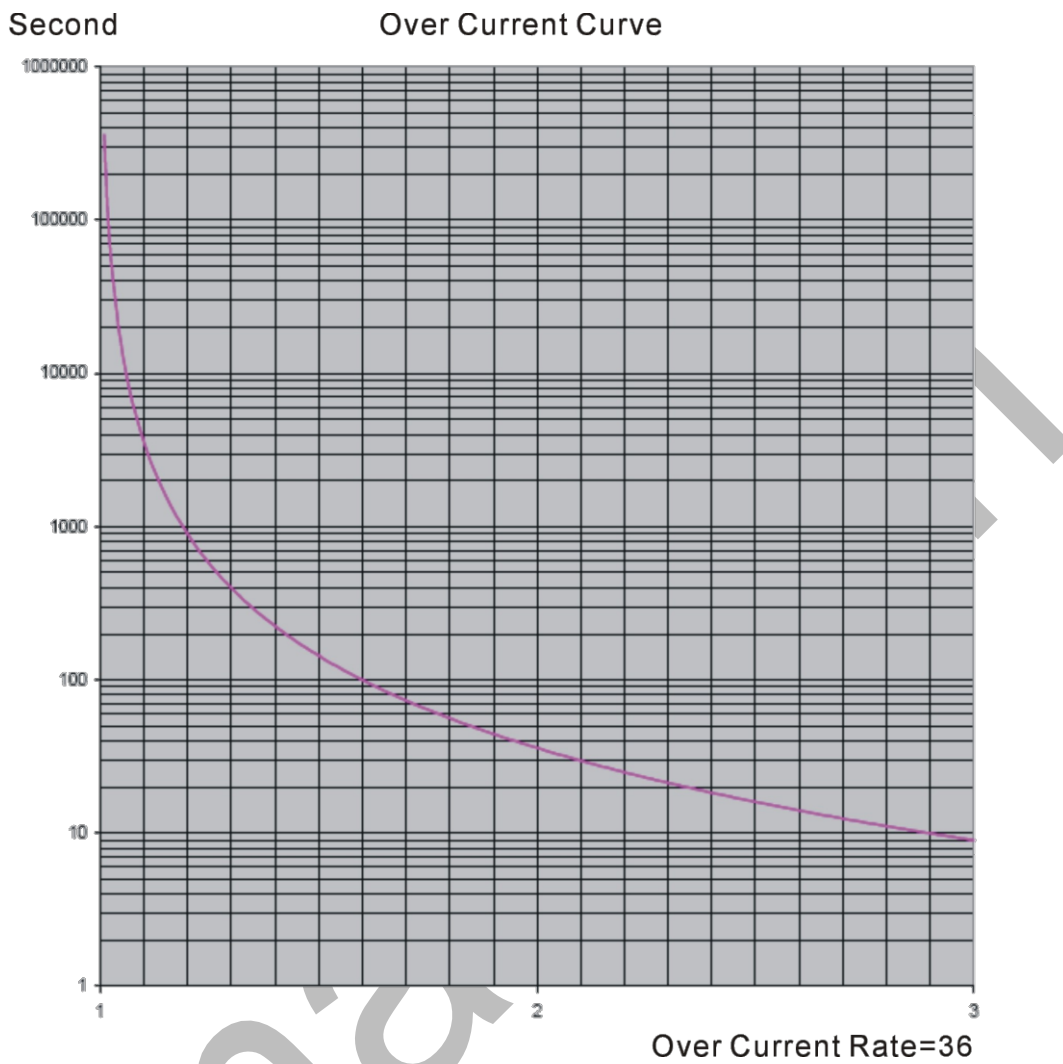

Please refer to **HGM6320T Test Software Manual** for further descriptions.

15 INSTALLATION

The controller is designed as plug-in mode, which is fixed by fixing clips when installed. The overall dimension and panel cutout are given as follows:

